

APPROVAL - CUSTOMER NAME & SIGNATURE	DATE

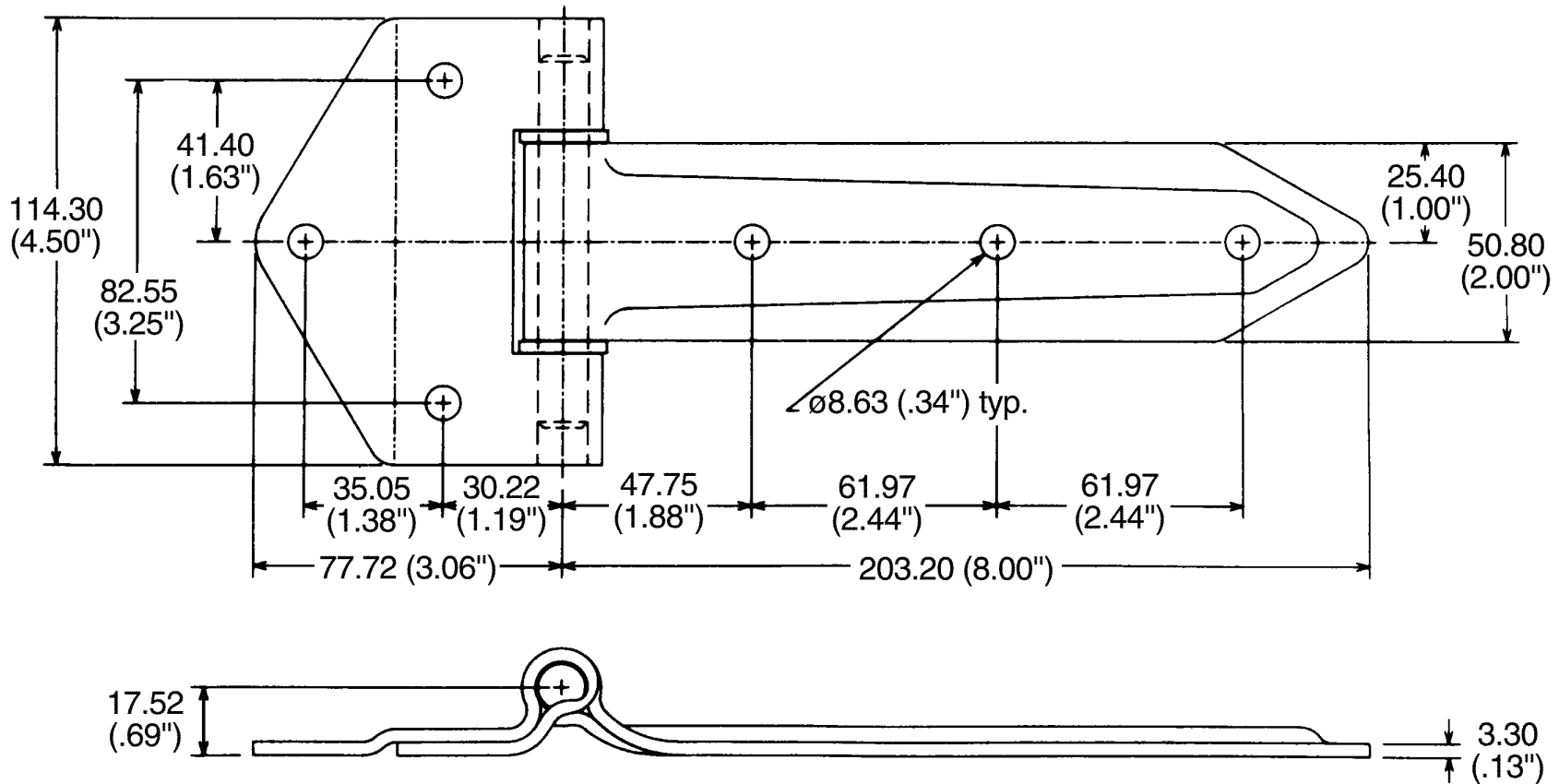

ALLEGIS	1-866-378-7550
MATERIAL:	DRAWING NO. : 5869 ZN
FINISH: Zinc	
REV.: 1:1	DATE: 6/12/2019